

## PlybooFit™ PF-22

**FSC® Certified**  
**FloorScore® Certified**  
**Formaldehyde Free**

- 1/4" Impact Cushioning, Noise Reducing Pad
- L.E.E.D. Contributions: MR4, MR6, MR7, IEQ4
- Average Hardness greater than Maple
- Greater Dimensional Stability than Maple
- Precision Milling, Fit, and Finish
- 6' Lengths
- 25 year warranty
- Soybond Formaldehyde Free Manufactured Flooring

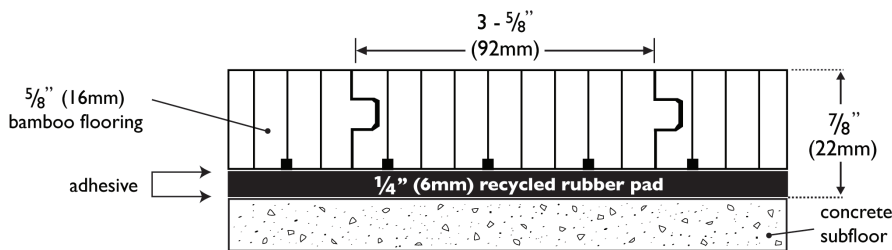

Plank Dimensions: 5/8" x 3 5/8" x 72"



Edge Grain, Amber  
FL-V5872PA-NAUF/FSC (Pre-finished)  
FL-V5872UA-NAUF/FSC (Unfinished)



Flat Grain, Amber  
FL-5872PA-NAUF/FSC (Pre-finished)  
FL-5872UA-NAUF/FSC (Unfinished)



Edge Grain, Natural  
FL-V5872PN-NAUF/FSC (Pre-finished)  
FL-V5872UN-NAUF/FSC (Unfinished)



Flat Grain, Natural  
FL-5872PN-NAUF/FSC (Pre-finished)  
FL-5872UN-NAUF/FSC (Unfinished)



Cert. # SCS-FS-02130  
As Certified by  
SCIENTIFIC CERTIFICATION SYSTEMS

## PlybooFit™ Strand PF-20

**FSC® Certified**  
**FloorScore® Certified**  
**Urea Formaldehyde Free**

- 1/4" Impact Cushioning, Noise Reducing Pad
- L.E.E.D. Contributions: MR4, MR6, MR7, IEQ4
- Average Hardness greater than Maple
- Greater Dimensional Stability than Maple
- Precision Milling, Fit, and Finish
- 6' Lengths
- 25 year warranty
- PlybooPure, No Added Urea-Formaldehyde

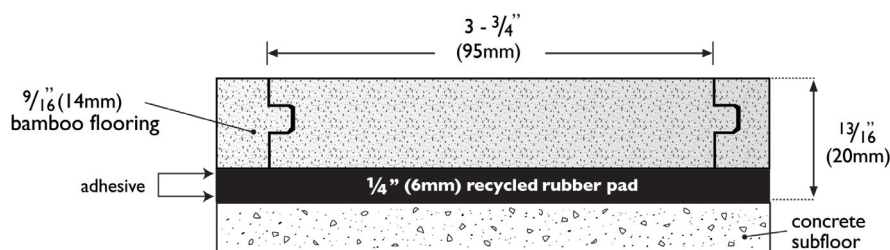

Plank Dimensions: 9/16" x 3 3/4" x 72"



Neopolitan  
Inquire for Pre-finished  
FL-P5872UNEO-NAUF/FSC (Unfinished)



PlybooStrand Sahara  
FL-P5872PH-NAUF/FSC (Pre-finished)  
FL-P5872UH-NAUF/FSC (Unfinished)

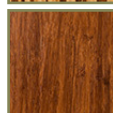

PlybooStrand Havana  
FL-P5872PD-NAUF/FSC (Pre-finished)  
FL-P5872UD-NAUF/FSC (Unfinished)



Cert. # SCS-FS-02130  
As Certified by  
SCIENTIFIC CERTIFICATION SYSTEMS

## PlybooFit™ Strand PF-16

**FSC® Certified**  
**FloorScore® Certified**  
**Urea Formaldehyde Free**

- 1/4" Impact Cushioning, Noise Reducing Pad
- L.E.E.D. Contributions: MR4, MR6, MR7, IEQ4
- Average Hardness greater than Maple
- Greater Dimensional Stability than Maple
- Precision Milling, Fit, and Finish
- 3' Lengths
- 25 year warranty
- PlybooPure, No Added Urea-Formaldehyde

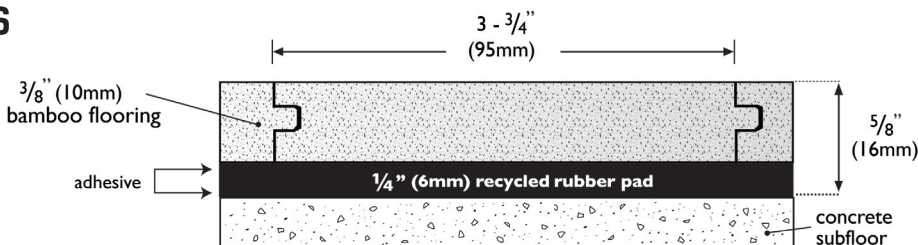

Plank Dimensions: 3/8" x 3 3/4" x 36"



Neopolitan  
FL-P3836NEO-NAUF/FSC (Pre-finished)



PlybooStrand Sahara  
FL-P3836PH-NAUF/FSC (Pre-finished)

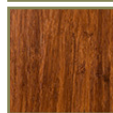

PlybooStrand Havana  
FL-P3836PD-NAUF/FSC (Pre-Finished)



Cert. # SCS-FS-02130  
As Certified by  
SCIENTIFIC CERTIFICATION SYSTEMS

# plybooFIT™



Natural Edge Grain  
FL-V3472SFN-NAUF/FSC



Amber Edge Grain (2,500 sq.ft. minimum)  
FL-V3472SFA-NAUF/FSC

## PlybooFIT ; PF-25 (part of the PlybooSport series)

### End View Detail

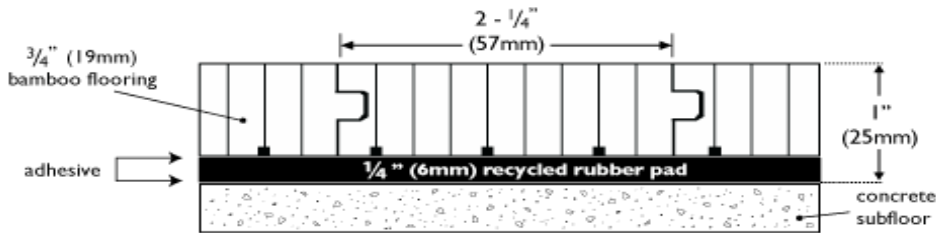

### Top View Detail



#### System Components :

System Components :		Profile		
top	<b>Bamboo Sport Surface</b> 3/4"x2 1/4"x72" (19mm x 95mm x 1829mm)	0.750"	3/4"	19mm
base	<b>1 layer of 1/4" PlybooFit sports padding</b> (93% post consumer content recycled rubber)	0.250"	1/4"	6mm
<b>T O T A L profile</b>		<b>1.00"</b>	<b>1"</b>	<b>25mm</b>

#### System Description :

L.E.E.D. contributors	MRc7 : Certified Wood : 100% FSC Bamboo				
	MRc6 : Rapidly Renewable Resource : (5 year forest replenishment + harvest)				
	MRc4 : (recycled content : 100% post consumer content recycled rubber padding)				
	IEQc4.3 : SoyBond Formaldehyde Free materials : (manufacturing) Floor Score certified				
	IEQc4.1,4.2, 4.4 : Low emitting materials : installer supplied)				
ID Innovation in Design +					
Colors (2)	Natural Edge grain FL-V3472-SFN-NAUF/FSC pre-sand 180grit FL-V3472-SFN-prefinished (inquire)		Amber Edge grain (2,500 sq.ft.order minimum) FL-V3472-SFA-NAUF/FSC pre-sand 180 grit FL-V3472-SFA-prefinished (inquire)		
Finishes (2)	Jobsite finished		Prefinished : (inquire)		
System Type	Fixed resilient				
Subfloor Construction	PlybooFIT - sports padding (93% post consumer content recycled rubber)				
Resilience	PlybooFIT- sports padding – 45 duro – product # PFR45B				
System Profile   Slab Depression	1 "	1.0"		25mm	
Sound Impact Insulation	IIC rating = 54 (over 6" concrete).			IIC rating = 58 (over 6" concrete/6" fiberglass)	
Industry Compliance	Fitness	Exercise	Yoga	Stage	Dance
Environmental Certifications	FSC, LEED		L.E.E.D		FloorScore
Warranty	25 years				

PlybooSport : [www.plyboosport.com](http://www.plyboosport.com) : 800.939.7397 : [lear@plyboosport.com](mailto:lear@plyboosport.com)

# plyboofIT™



Amber Squared  
FL-EG-5836PA-NAUF/FSC  
FL-EG-5836UA-NAUF/FSC

Natural Squared  
FL-EG5836PN-NAUF/FSC  
FL-EG5836UN-NAUF/FSC

## PlybooFIT Squared : PF22-Squared

### End View Detail

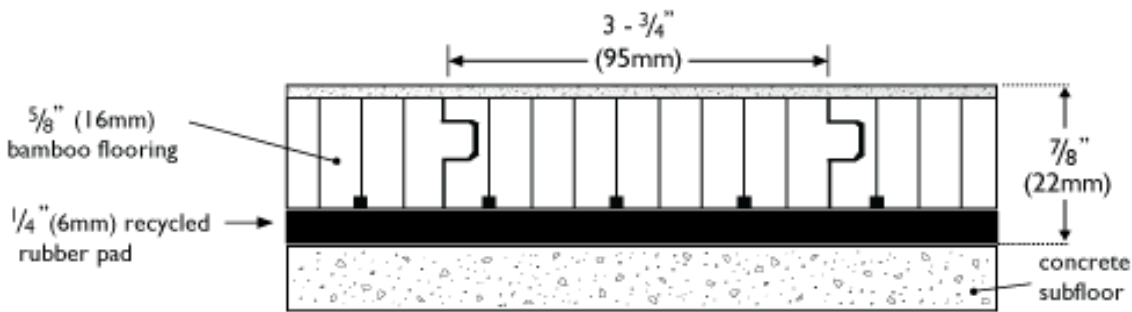

### Top View Detail

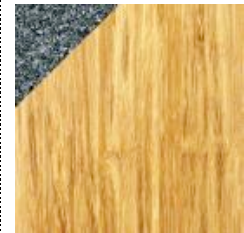

#### System Components :

System Components :		Profile		
Top	Plyboo bamboo surface 5/8" x 3 3/4" x 37 3/4" (16mm x 95 mm x 960mm) Amber and Natural Squared	0.625"	5/8"	16mm
Base	1 layer of 1/4" PlybooFit sports padding (93% post consumer content recycled rubber) –PFR45B	0.250"	1/4"	6mm
TOTAL		0.875"	7/8"	22mm

#### System Description :

L.E.E.D. contributors	MRc7 : Certified Wood : 100% FSC : Bamboo				
	MRc6 : Rapidly Renewable				
	IEQc4.3 : Low emitting materials (manufacturing) FloorScore certified, CA section 01350 tested				
	IEQc4.1,4.2, 4.4 (installer supplied)				
	IEQc6.1,6.2 (recycled content : 93% post consumer content (recycled rubber padding)				
ID Innovation in Design + FloorScore certified					
Colors (2)	Amber Squared FL-EG5836PA-NAUF/FSC FL-EG5836UA-NAUF/FSC		Natural Squared FL-EG5836PN-NAUF/FSC FL-EG-5836UN-NAUF/FSC		
Finishes (2)	Jobsite finished = UN or UA		Prefinished = PN or PA		
System Type	Fixed resilient (glue down)				
Subfloor Construction	PlybooFIT - sports padding (93% post consumer content recycled rubber) –				
Resilience	PlybooFIT- sports padding – 45 duro (93% post consumer content recycled rubber) – product # PFR45B				
System Profile   Slab Depression	7/8"		0.875"		22mm
Industry Compliance	Fitness	Exercise	Yoga	Stage	Dance
Environmental Certifications	FSC		L.E.E.D		FloorScore
Warranty	25 years				

# plybooFIT™

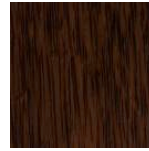
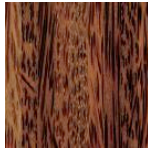

FL-5872PPN-NAUF

FL-5872PPN-SG-NAUF

FL-P5872-PPE-NAUF

FL-V5872PPN-NAUF

FL-P5872PPD-NAUF

FL-V5872PPN-SG

FLAT GRAIN COCONUT

FLAT GRAIN SUGAR

FLAT GRAIN EBINY

EDGE GRAIN COCONUT

FLAT GRAIN COCONUT DARK

DECO PALM SUGAR

## PlybooFit - PF22 PALM

### End View Detail

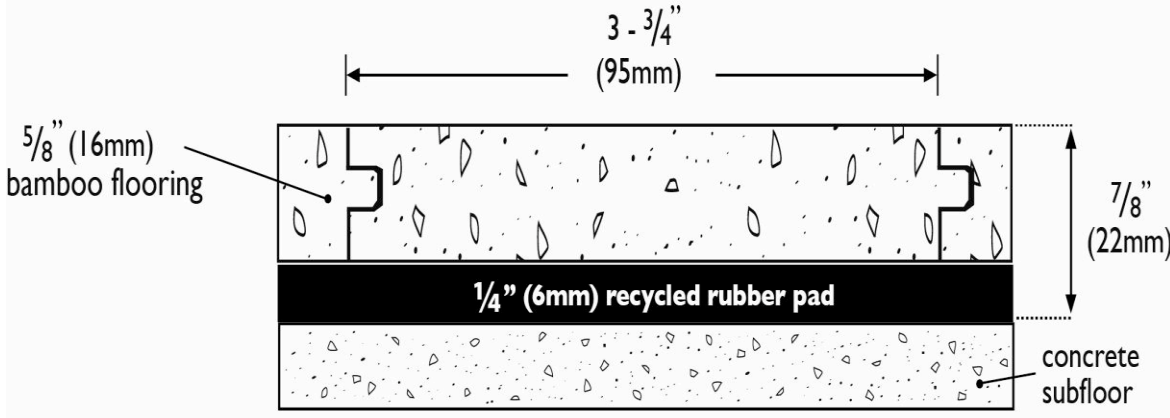

### Top View Detail



### System Components

System Components		Profile		
top	Durapalm Athletic Surface 5/8"x3"x 24" to 72" (16mm x 76m x 610mm to 1828mm)	0.625"	5/8"	16mm
base	1 layer of 1/4" PlybooFit sports padding (93% post consumer content recycled rubber padding)	0.250"	1/4"	6mm
TOTAL		0.875"	7/8"	22mm

### System Description :

L.E.E.D. contributors	MRc7 : Certified Wood ; FSC Palm					
	MRc7 : FSC sub-floor : installer supplied)					
	MRc3 : Reclaimed Agrifiber (recovered Palm tree turnck)					
	MRc4 ; Recycled Content : 95% post consumer content recycled rubber padding					
	IEQc4.3 : Low emitting materials (manufacturing) + FloorScore Certified – section1350					
	IEQc4.1,4.2, 4.4 Low emitting materials (installer supplied)					
ID : Innovation in Design						
Colors (6)	Flat Grain Coconut	Flat Grain Sugar	Flat Grain Coconut Dark	Flat Grain Ebony	Edge Grain Ebony	DecoPalm Sugar
Finishes (2)	Prefinished or Unfinished					
System Type	Fixed resilient (glue down)					
Subfloor Construction	PlybooFIT - sports padding (93% post consumer content recycled rubber) –					
Resilience	PlybooFIT- sports padding – 45 duro – product # PFR45B					
System Profile   Slab Depression	7/8"	0.875"		22mm		
Sound Impact Insulation	IIC rating = 54 (over 6" concrete)			IIC rating = 58 (over 6" concrete/6" fiberglass)		
Industry Compliance	Fitness	Exercise	Yoga	Stage		Dance
Environmental Certifications	FSC		L.E.E.D	FloorScore		
Warranty	25 years					

# plybooFIT™



Havana Strand  
FL-P5872PD-NAUF/FSC  
FL-P5872UD-NAUF/FSC



Neopolitan Strand  
FL-P5872-UNEO-NAUF/FSC  
FL (9/16" Neo available unfinished only)



Sahara Strand  
FL-P5872PH-NAUF/FSC  
FL-P5872UH-NAUF/FSC

## PlybooFIT : PF20-Strand PlybooFIT : PF20-StrandClic

### End View Detail : PF20-Strand

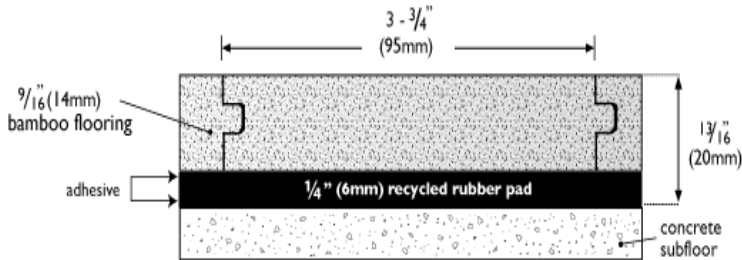

### End View Detail : PF20-StrandClic

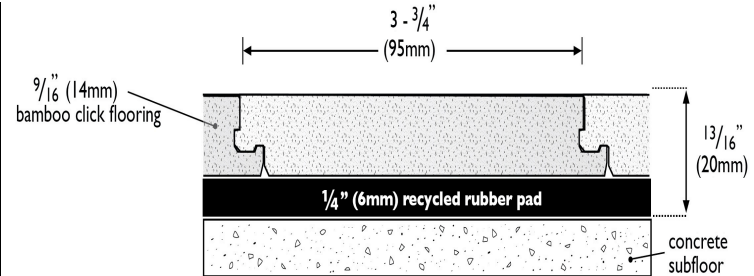

#### System Components :

System Components :		Profile		
top	Plyboo Strand Bamboo : 9/16" surface 9/16"x3 3/4"x72" (14mm x 95mm x 1829mm)	0.562"	9/16"	14mm
base	1 layer of 1/4" PlybooFIT sport padding (100% post consumer content recycled rubber) – PFR45B	0.250"	1/4"	6mm
TOTAL		0.812"	13/16"	20mm

#### System Description :

L.E.E.D contributors	MRc7 : Certified Wood : 100% FSC Bamboo					
	MRc6 : Rapidly Renewable Resource (5 year forest replenishment – harvest)					
	MRc4 : Recycled Content : 93% post consumer content recycled rubber pad					
	IEQc4.3 : Low emitting materials (manufacturing) + FloorScore certified, CA section 1350 tested					
	IEQc4.1,4.2,4.4 : Low emitting materials (installer supplied)					
	ID : Innovation in Design					
Colors (3)	Havana Strand FL-P5872PD-NAUF/FSC		NeopolitanStrand FL-P5872UNEO-NAUF/FSC		SaharaStrand FL-P5872PH-NAUF/FSC	
Finishes (2)	Prefinished = PH or PD		Unfinished = UH or UD		9/16" Neopolitan available unfinished only	
System Type	Fixed resilient (glue down)			Floating resilient (clic-loc)		
Subfloor Construction	PlybooFIT - sports padding (93% post consumer content recycled rubber)					
Resilience	PlybooFIT- sports padding – 45 duro – Product # PFR-45B					
System Profile   Slab Depression	13/16"		0.812"		20mm	
Industry Compliance	Fitness	Exercise	Yoga	Stage	Dance	General
Environmental Certifications	FSC		L.E.E.D		FloorScore	
Warranty	25 years					

plybooFIT | [www.plyboofit.com](http://www.plyboofit.com) | 866.835.9859 | [fit@plyboo.com](mailto:fit@plyboo.com)

# plybooFIT™



Havana Strand  
FL-P3836PD-NAUF/FSC



Neopolitan Strand  
FL-P3836-NEO-NAUF/FSC



Sahara Strand  
FL-P3836PH-NAUF/FSC

## PlybooFIT : PF16-Strand PlybooFIT : PF16-StrandClic

### End View Detail : PF16-Strand

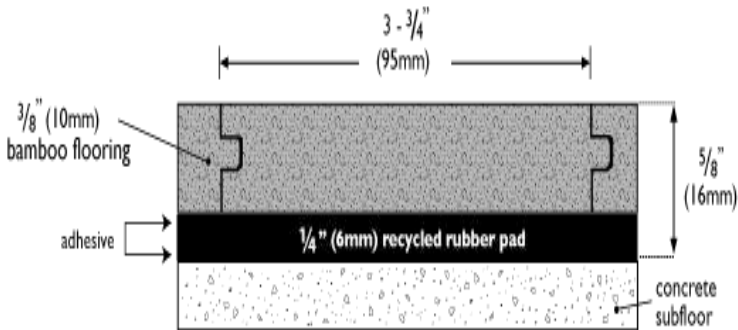

### End View Detail : PF16-StrandClic

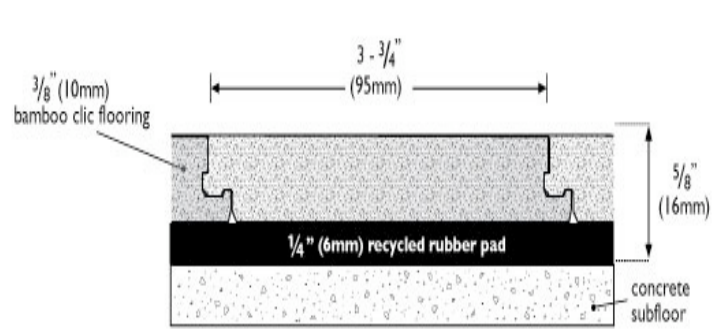

#### System Components :

System Components :		Profile		
top	Plyboo Strand Bamboo : 3/8" surface 3/8"x3 3/4"x36" (10mm x 95mm x 915mm)	0.375"	3/8"	9mm
base	1 layer of 1/4" PlybooFIT sport padding (100% post consumer content recycled rubber) – PFR45B	0.250"	1/4"	6mm
TOTAL		0.625"	5/8"	16mm

#### System Description :

L.E.E.D contributors	MRc7 : Certified Wood : 100% FSC Bamboo					
	MRc6 : Rapidly Renewable Resource (5 year forest replenishment – harvest)					
	MRc4 : Recycled Content : 93% post consumer content recycled rubber pad					
	IEQc4.3 : Low emitting materials (manufacturing) + FloorScore certified, CA section 1350 tested					
	IEQc4.1,4.2,4.4 : Low emitting materials (installer supplied)					
ID : Innovation in Design						
Colors (3)	Havana Strand FL-P3836PD-NAUF/FSC	NeopolitanStrand FL-P3836NEO-NAUF/FSC	SaharaStrand FL-P3836PH-NAUF/FSC			
Finishes (2)	Prefinished 3/8" x 3-3/4" x 36" Plyboo Strand available pre-finished only					
System Type	Fixed resilient (glue down)			Floating resilient (clic-loc)		
Subfloor Construction	PlybooFIT - sports padding (93% post consumer content recycled rubber)					
Resilience	PlybooFIT- sports padding – 45 duro – Product # PFR-45B					
System Profile   Slab Depression	5/8"		0.625"		16mm	
Industry Compliance	Fitness	Exercise	Yoga	Stage	Dance	General
Environmental Certifications	FSC		L.E.E.D		FloorScore	ISO
Warranty	25 years					

PlybooSport is:

## Soybond Manufactured FSC® and FloorScore® Certified Formaldehyde Free

- L.E.E.D. Contributions: MR6, MR7, IEQ4
- Average Hardness greater than Maple
- Consistent lighter color and 6' lengths
- Precision Milling, Fit, and Finish
- Exceeds visual rating of Grade 1 Maple
- Priced competitively to Grade 1 Maple
- ASTM, EN, FIBA, DIN Compliant
- 25 year warranty



Edge Grain, Natural  
FL-V3472SFN-NAUF/FSC



Edge Grain, Amber  
FL-V3472SFA-NAUF/FSC  
(minimum order 2,500 sq. ft.)

### Dimensions:

U.S. Standards/ Metric

3/4" x 2 1/4" x 72" (19mm x 57mm x 1829mm)

1 1/4 sq. ft./board (0.104 m<sup>2</sup>/board)

20 boards/box

22.5 sq. ft./box (2.09 m<sup>2</sup>/box)

### Weight:

U.S. Standards/ Metric

2.53 lbs./sq. ft. (1.235 kg/m<sup>2</sup>)

2.85 lbs./board (1.29 kg/board)

57 lbs./box (25.9 kg/box)

50 boxes/pallets

2,930 lbs/pallet (1,329 kg/pallet)

### L.E.E.D. Contributions

Manufacturer:

MRc4: Recycled Materials (Rubber Pad)

MRc6: Rapidly Renewable Materials

MRc7: FSC® Certified (SW-COC-003124)

IEQc4.3: Low-Emitting Materials

CA Section 01350 Compliant

FloorScore® Certified (SCS-FS-02130)

Installer Supplied:

MRc7: FSC-Certified Subfloor Materials

IEQ 4.1, 4.2: Low-Emitting Materials

### Floating Resilient Sleeper

PS-3.125-CP

- SOFT TOUCH-Y
- MULTI-USE-W
- PRO-B

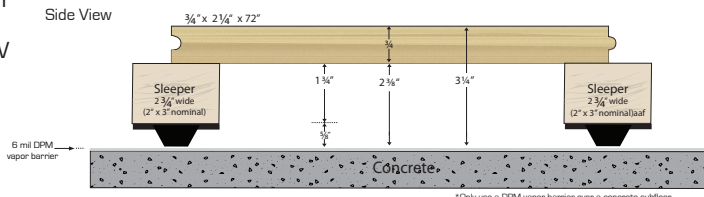

\*Only use a DPM vapor barrier over a concrete subfloor

### Floating Resilient Sleeper + Panel

PS-3.625-CP

- SOFT TOUCH-Y
- MULTI-USE-W
- PRO-B

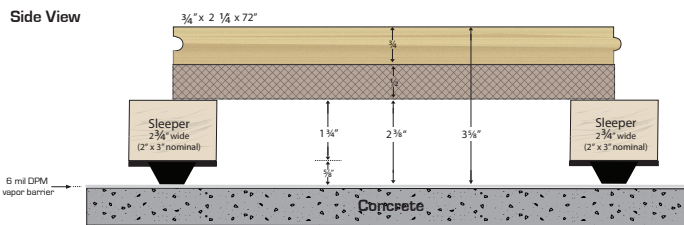

\*Only use a DPM vapor barrier over a concrete subfloor

### Floating Resilient Panel

PS-1.875CP, PS-1.937-CP, PS-2.125-CP, PS-2.375-CP

- SOFT TOUCH-Y
- MULTI-USE-W
- PRO-B

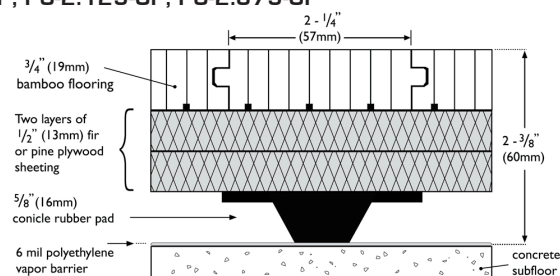

### Fixed Resilient Anchored

PS-2.125A-CP; PS-2.375A-CP

- SOFT TOUCH-Y
- MULTI-USE-W
- PRO-B

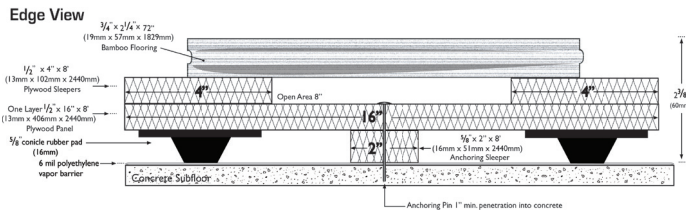

### Fixed Resilient PlybooFIT

PF-3472-1.0

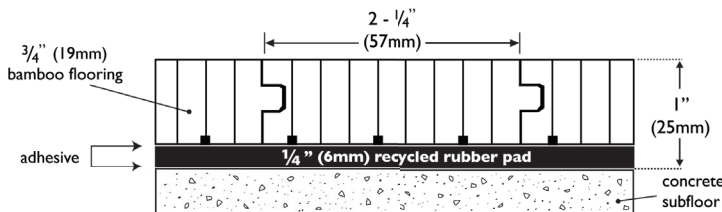

Cert.# SCS-FS-02130  
As Certified by  
SCIENTIFIC CERTIFICATION SYSTEMS



The mark of responsible forestry